

ELECTRONIC HEARING PROTECTION FOR MUSICIANS

Robert Albrecht

Aalto University

Department of Computer Science

robert.albrecht@aalto.fi

Jussi Jaatinen

University of Helsinki

Musicology

jussi.o.jaatinen@helsinki.fi

Tapio Lokki

Aalto University

Department of Computer Science

tapio.lokki@aalto.fi

ABSTRACT

Many people are exposed to large sound pressure levels either occasionally or regularly, and thus need to protect their hearing in order to prevent hearing loss and other hearing disorders. Earplugs are effective at attenuating sound from the environment, but they do not attenuate bone-conducted sound, but instead amplify it at low frequencies due to the occlusion effect. This is a problem, e.g., for many musicians and especially wind instrument players, since this low-frequency amplification greatly affects the sound of their own instruments. This makes it difficult for the musicians to play while using hearing protectors, and therefore many musicians choose not to use hearing protectors at all. In this paper, we propose electronic hearing protectors that mitigate the problems associated with musicians' hearing protection through several different approaches: reduction of the occlusion effect, adjustable attenuation with natural timbre, and monitoring of the musician's own instrument. We present the design of prototype electronic hearing protectors and the evaluation of these by professional musicians, where they were shown to alleviate the problems associated with conventional hearing protectors.

1. INTRODUCTION

Musicians, among others, are exposed to large sound pressure levels that may over time lead to hearing loss, hyperacusis, and tinnitus. Since the sound pressure caused by the musicians' instruments or the PA system often cannot be limited to safe levels during rehearsals and especially during concerts, personal hearing protection must be used to limit the noise exposure. Hearing protection – typically earplugs when it comes to performing musicians – is effective for attenuating the sound of other musicians playing in an ensemble. However, plugging the ears with hearing protectors makes the sound of the musician's own instrument unnatural. The main reason for this is that part of the sound reaches the inner ear through bone conduction. This bone-conducted sound is not attenuated by the earplugs, but instead amplified by them, and is often very different from the normal air-conducted sound of the instrument.

This is a problem, e.g., for wind instrument players, who get a large degree of bone-conducted sound from their in-

struments. Double-reed instruments, such as the oboe and the bassoon, are especially problematic, since the vibrating mouthpiece produces a buzzing sound that also disturbs the musician's perception of the pitch of his or her own instrument. Also violinists are affected, since they rest the instrument against their jaws. Singers are equally affected by the problem, as is any musician or other person speaking while wearing hearing protection.

An earplug-occluded ear canal amplifies bone-conducted sound up to 30 dB at low frequencies due to the occlusion effect [1]. Together, the attenuation of air-conducted sound and the amplification of bone-conducted sound causes the sound of the instrument to appear distorted to the musician him- or herself. For this reason, as well as other reasons, many musicians are reluctant to use hearing protection [2] and therefore often suffer from hearing disorders [3]. Another problem when using earplugs is the change in timbre when the ear canal is blocked [4].

In this paper, we present the design and evaluation of an electronic hearing protection solution aimed particularly at musicians. The solution consists of noise-attenuating insert headphones with microphones both inside the ear canal and on the outside of the headphones. The in-ear microphones are used for partial cancellation of the occlusion effect with the help of a negative feedback circuit, while the microphones outside can be used for hear-through purposes, resulting in hearing protectors with adjustable attenuation. Additional microphones are used to pick up the sound of the instrument. This sound can then be reproduced at a desired level, in order to restore some of the natural balance between the air-conducted and the bone-conducted sound of the instrument.

2. BACKGROUND AND RELATED RESEARCH

In a survey among five major classical orchestras in the Helsinki region, Finland, 31% of the 196 musicians that answered the survey reported some degree of hearing loss, 37% reported temporary tinnitus (15% of the women and 18% of the men reported permanent tinnitus), and 43% reported having hyperacusis [2]. These hearing problems were also associated with a high level of stress: the musicians with hearing problems had three to nine times more stress than the other musicians.

In the same survey, 69% of the musicians were at least somewhat worried about their hearing. However, only 6% of the musicians always used hearing protectors during rehearsals and performances. Musicians often only start using hearing protectors once they have developed hearing

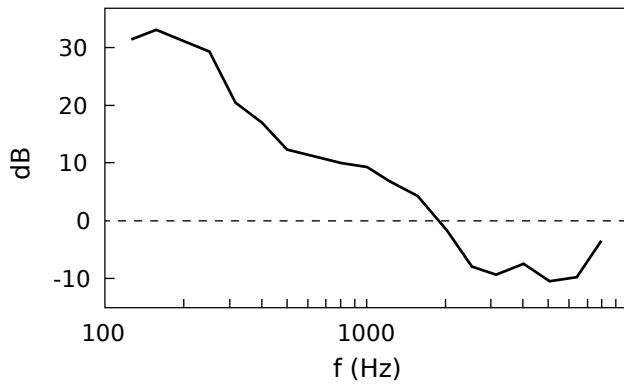

Figure 1: The occlusion effect measured as the change in sound pressure when blocking the ear canal with a shallowly inserted foam earplug [1]. The excitation signal was produced by a bone-conduction transducer.

problems: 20% of the musicians with hearing problems used hearing protectors, while 6% of the musicians without hearing problems used hearing protectors. Among the musicians that answered the questionnaire, 47% used custom-molded earplugs, while 25% used disposable earplugs.

According to the survey, the main reason why many classical musicians do not use hearing protectors is that it hinders their own performance ($n=155$). The second largest reason is that earplugs make it difficult to hear other musicians in an ensemble ($n=88$). Further reasons are that the sensation of hearing protectors is unpleasant ($n=15$) and that they are difficult to insert ($n=12$).

One specific problem when using hearing protectors both hindering the musician's own performance and making it difficult to hear others play is the occlusion effect. In a normal situation the ear canal is open and the bone-conducted sound energy transmitted from the musician's own instrument into the ear canal through vibration of the ear canal walls exits to a large degree through the ear canal opening. When the ear canal is blocked with an earplug, much of the bone-conducted sound energy is directed to the eardrum. This causes the amplification of low-frequency sound, which is referred to as the occlusion effect. Another way to describe the occlusion effect is that the open ear canal acts as a high-pass filter, but occluding the ear canal removes this high-pass filter which causes low frequencies to become louder [1].

Figure 1 shows the occlusion effect measured by the increase in sound pressure when occluding the ear canal with a shallowly inserted foam earplug. As shown, the sound pressure produced by a bone-conduction transducer is amplified approximately 30 dB at frequencies between 100 and 200 Hz. Above these frequencies, the occlusion effect gradually decreases: at 1 kHz, the amplification is approximately 10 dB, while no amplification is observed at 2 kHz and above.

The low-frequency boost caused by the occlusion effect causes two problems for musicians using earplugs. Firstly, it colours the sound, making it darker and boomy. This makes it difficult for the musicians to hear the nuances of the sound of their own instruments. Secondly, the boost

makes the musicians' own instruments sound louder when compared to the sound of the rest of the orchestra. This makes it difficult for the musicians to hear the rest of the orchestra, and to balance the dynamics of their own instruments with the orchestra.

There are several different approaches that can be utilized in order to mitigate the occlusion effect. Inserting earplugs deeper into the ear canals reduces the area of the ear canal walls that radiates bone-conducted sound and thereby also reduces the occlusion effect [1]. Deep earplugs are, however, often perceived as uncomfortable. On the other hand, using large earmuffs instead of earplugs also reduces the occlusion effect [1]. These are usually not used by performing musicians due to aesthetic reasons. Finally, vents can be used to allow the low-frequency energy in the ear canal to escape. This might be a useful approach in hearing aids, but in hearing protectors it will not only reduce the occlusion effect but also reduce the effectiveness of the hearing protection at low frequencies.

A further approach is to utilize noise-cancellation techniques in order to cancel out the bone-conducted sound radiating into the ear canal. In this case, the bone-conducted sound is recorded inside the ear canal and simultaneously played back from the earplug in opposite phase. The resulting destructive interference reduces the sound pressure inside the ear canal and thereby also reduces the occlusion effect.

Several previous studies have tried and succeeded in reducing the occlusion effect caused by an earplug using miniature microphones and loudspeakers inside the ear canal. The majority of this research has been done in the field of hearing aids. Mejia et al. [5] combined analog negative feedback with an acoustic vent, and were able to reduce the occlusion effect in hearing aids by 15 dB. Test subjects reported that their own voice was more natural when using this occlusion reduction.

Borges et al. [6] developed an adaptive occlusion canceller for hearing aids, obtaining an average attenuation of 6.3 dB. The test subjects reported that the occlusion canceller created a sensation of their "ears opening." Sunohara et al. [7] also proposed an adaptive system for reducing the occlusion effect. Computer simulations of the proposed algorithm showed a maximum occlusion reduction of 30 dB. However, due to the adaptive nature of the algorithm, the effectiveness of the reduction varied over time.

Bernier and Voix [8] proposed a hearing protection solution for musicians similar to the one presented in this paper, but without monitoring of the musician's own instrument. Analog negative feedback was used to reduce the occlusion effect, while signals from microphones on the outside of the hearing protectors were processed with a digital signal processor and reproduced through the miniature loudspeakers inside the ear canals in order to obtain adjustable attenuation with natural timbre. The solution was able to achieve a reduction of the occlusion effect of approximately 10 dB. Bernier and Voix also proposed to compensate for the non-linearity of loudness perception in order to make the timbre independent of the current attenuation of the hearing protectors.

3. TECHNICAL SOLUTION

Our electronic hearing protection solution combines several different techniques in order to solve the problems mentioned earlier. The whole solution is illustrated with a block diagram in Fig. 2, while Fig. 3 depicts the location of the microphones connected to the hearing protectors. The designed system consists of the following parts:

- Insert headphones are utilized as earplugs to provide passive attenuation of air-conducted sound.
- Microphones inside the ear canals are used to reduce the occlusion effect through negative feedback.
- Microphones outside the headphones pick up sound from the environment which is reproduced through the headphones at a desired level, resulting in the hearing protectors having adjustable attenuation.
- Additionally, the musician's own instrument can be close-miked to provide in-ear monitoring of the instrument, increasing the ratio of air-conducted to bone-conducted sound and thus providing the musician with a more natural sound of the instrument.

In the current solution, Akustica AKU143 MEMS microphones are used. The signals from the hear-through and instrument microphones are processed at a sampling rate of 48 kHz on an Analog Devices ADAU1442 digital signal processor (DSP). The headphones used are Sennheiser OCX 686G insert headphones.

3.1 Occlusion reduction

As stated earlier, there are many approaches available to alleviate the occlusion effect, but all of them have their disadvantages. Our solution is an analog electroacoustic negative feedback circuit, which partly cancels out the amplification of low frequencies caused by the occlusion effect. The feedback loop inverts the signal and applies a second-order low-pass filter at 1.1 kHz to avoid instability at higher frequencies. The processing is performed with analog electronics in order to minimize the phase shift and allow the occlusion reduction to be effective at as high frequencies as possible.

The chosen approach not only attenuates low frequencies amplified by the occlusion effect, but it attenuates low frequencies inside the ear canal independent of their origin. The negative feedback loop thus also provides improved attenuation of low-frequency air-conducted sound.

3.2 Adjustable attenuation and natural timbre

Employing microphone hear-through techniques [4,9] provides the possibility to adjust the amount of attenuation, from the full attenuation provided by the insert headphones tightly fit in the ear canals, together with the occlusion reduction, to no attenuation at all. The amount of attenuation can thus be chosen for different situations according to the need of the user.

The microphone hear-through technique utilizes microphones attached to the outside of the headphones, one at each ear. The signals from these microphones can be amplified to the desired level, and reproduced through the headphones. The microphones should be placed as close as possible to the ear canal entrances, to avoid colouration of the sound picked up by them. To achieve natural timbre, the signals must also be equalized, in order to compensate for the magnitude response of the headphones as well as the changes in resonances when blocking the ear canals. For this task, the DSP was used. The headphone response with the occlusion reduction circuit active was first flattened using four notch filters and one peak filter, to produce an approximately flat response at the eardrum inside an ear canal simulator. The quarter-wavelength resonance present in an open ear canal was then added using a peak filter, together with the three-quarter-wavelength resonance using another peak filter. The filters were tuned to match the target response proposed by Hoffmann et al. [10].

3.3 Monitoring of the musician's own instrument

The occlusion reduction circuit eliminates much of the amplification of low-frequency bone-conducted sound caused by occluding the ear canals. However, even if all of this amplification were eliminated, the attenuation of the air-conducted sound would cause the bone-conducted sound to be more prominent than with unoccluded ear canals. The timbre of the musician's own instrument would thus still sound unnatural. To compensate for this imbalance, we use up to four microphones attached to the instrument. These microphones pick up the air-conducted sound of the instrument that can be appropriately amplified and reproduced through the headphones to achieve a satisfactory balance between bone-conducted and air-conducted sound and thus a more natural timbre. The maximum of four instrument microphones was at this stage chosen to give enough possibilities to try different microphone setups with different instruments.

It is, however, not adequate to simply reproduce these microphone signals as such. First of all, the air-conducted sound heard from the instrument is normally affected by the body and especially the head and pinnae of the musician, altering the spectral and temporal characteristics of the sound that enters each ear. These modifications to the sound serve as cues for the human auditory system to infer that the sound source is in a specific direction. If these modifications are absent, the sound will be perceived to originate from inside the head, and it will also have an unnatural timbre.

Second, sound from the instrument normally also reaches the musician's ears through reflections from different surfaces in the surrounding space. Since the microphones are placed close to the instrument, in order to pick up the sound of this instrument and as little as possible of the other musicians' instruments, they will also pick up very little of the reflections from the environment. Without these naturally occurring reflections, the sound of the instrument will feel "dry" and "out of place," and the absence of reflections will also make it more likely that the sound of the instrument is

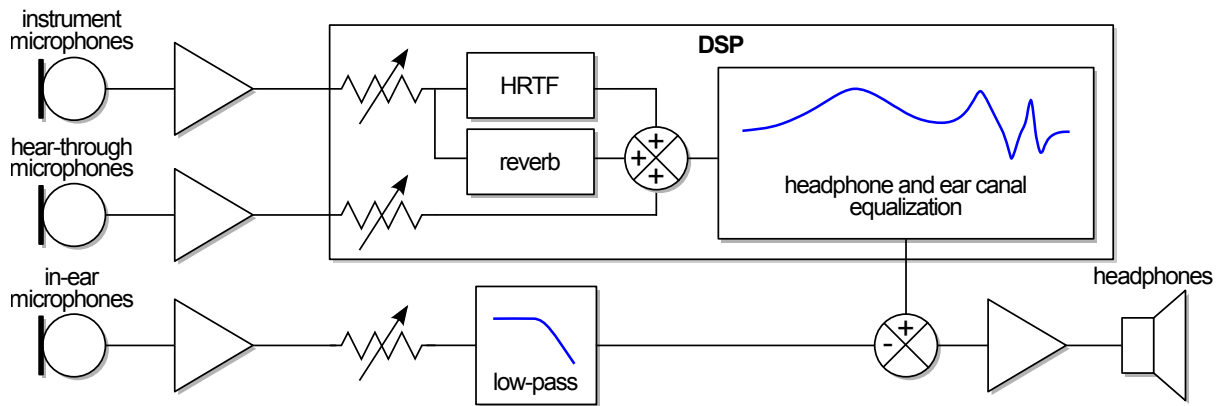

Figure 2: Block diagram of the electronic hearing protection solution.

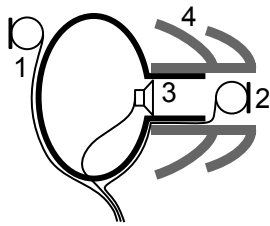

Figure 3: Diagram of the hearing protectors and the attached microphones: 1. hear-through microphone, 2. in-ear microphone. 3. headphone driver, and 4. rubber tip.

perceived as originating inside the musician’s head.

To solve the mentioned problems, two different approaches were combined. First, head-related transfer functions (HRTFs) were applied to the mixed instrument microphone signals. HRTFs describe the effects that the head and torso have on the sound reaching each ear from a certain direction, under otherwise anechoic conditions. With HRTFs applied to the sound of the instrument, it will sound as if arriving from a certain direction, due to the HRTFs containing different cues that the auditory system uses for sound source localization. Additionally, since people normally perceive sound through HRTFs, so to speak, they are accustomed to the timbre that these produce, so applying HRTFs will make the timbre more natural.

In addition to using HRTFs, we employ reverberation in order to integrate the “dry” sound of the instrument into the surrounding acoustic environment. For the evaluation, we utilized the reverberation algorithm readily available on the DSP, and adjusted the few available parameters to fit it to the surrounding environment as well as possible. Adding reverberation not only helps with integration, but also aids in externalization [11].

3.4 Details on HRTFs

Because people have different sizes of heads and ears, ideally the individual HRTFs of the person in question should be used, in order to achieve totally natural localization cues and timbre. Measuring individual HRTFs is, however, currently not feasible on a large scale, so generic HRTFs were instead chosen here. For the evaluation, we used near-field

HRTFs of a KEMAR head and torso simulator [12]. To represent the direction of many wind instruments, with respect to the head of the musician, an elevation of -30° was chosen. An azimuth of -10° was chosen in favour of an azimuth of 0° (straight forward), since HRTFs measured at 0° azimuth often reduce externalization [11], i.e., sounds presented with them are perceived as originating from inside the head. The HRTFs were measured at a distance of 20 cm from the centre of the head, thus simulating a sound source a small distance in front of the mouth.

Naturally, different instruments are played in different positions, so the HRTFs should be selected based on the instrument. If the instrument is not always kept in the same direction with respect to the head, tracking of the instrument position might be beneficial. With most wind instruments, however, this should not be a problem, since they are normally kept in the same direction with respect to the head. Although the chosen azimuth and elevation of the HRTFs may not correspond perfectly with the location of the instrument, this should not be a problem unless the mismatch is large. Due to the ventriloquism effect [13], small mismatches are ignored and the sound should be heard as if coming from the instrument.

4. VALIDATION

The prototype electronic hearing protection system constructed in order to evaluate the proposed solution is shown in Fig. 4. Measurements were performed in order to quantify the effect of the occlusion reduction circuit, as well as for tuning the headphone equalization. To evaluate the sound of the electronic hearing protectors, they were tested by seven professional musicians.

4.1 Measurements

For the measurements, we constructed an ear canal simulator out of a silicone tube with an inner diameter of 10 mm and a length of 27 mm. One end of the tube was glued to a piece of hard plastic, simulating the eardrum, and a MEMS microphone was attached to the plastic. The magnitude response of the headphones under different conditions was measured using white noise.

Figure 5 shows the magnitude response of the headphones without and with the occlusion reduction circuit

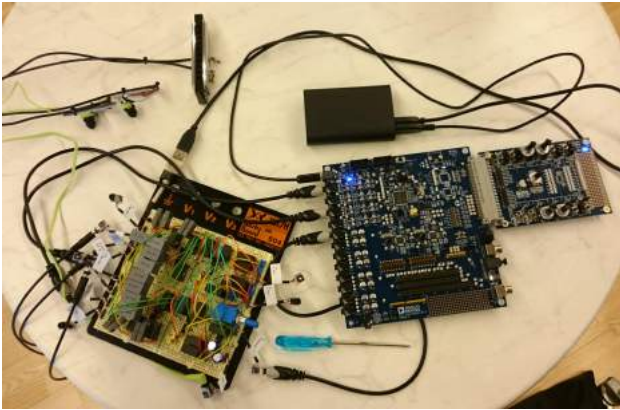

Figure 4: The prototype electronic hearing protection solution, consisting of a breadboard with analog electronics, a DSP evaluation board, a USB battery pack, headphones with attached microphones, and a harmonica with two attached instrument microphones.

in action. Figure 6 shows the reduction of the occlusion effect achieved with the occlusion reduction circuit. The occlusion reduction is at most approximately 13 dB at 150 Hz, and more than 10 dB between 100 and 300 Hz. At the same time the peak in the headphone response between 5 and 6 kHz is amplified since the feedback loop is not in opposite phase any more at this frequency. Much further amplification in the feedback loop results in an even larger peak and finally instability at this frequency. The amplification of the feedback loop was thus chosen as a compromise between attenuation at low frequencies and amplification and stability at high frequencies.

Frequencies below 50 Hz are amplified, with a maximum amplification of 12 dB. This low-frequency boost is due to the phase shift introduced by DC-blocking capacitors in the occlusion reduction feedback loop. Future design efforts should try to mitigate this problem, e.g., by using larger capacitances that would shift these high-pass filters to lower frequencies and reduce the boost.

Figure 7 depicts the equalization of the headphone response, which is applied to the signals from both the hear-through microphones and the instrument microphones (as shown in Fig. 2). The equalized response resembles the target response proposed by Hoffman et al. [10], and should thus provide a fairly natural timbre for the signals reproduced through the headphones. Note that since the occlusion reduction circuit affects not only the bone-conducted sound entering the ear canal, but also the signals that are reproduced through the headphones, the headphone equalization must compensate for the notch caused by the occlusion reduction.

4.2 Subjective evaluation

The prototype electronic hearing protection solution was informally evaluated by seven professional musicians. One of the participants was a jazz musician, while the rest were members of either the Helsinki Philharmonic Orchestra or the Finnish National Opera. All musicians tested the hearing protectors with their own instruments, which were the

tenor saxophone, viola, bassoon, trumpet, flute and piccolo, clarinet, and oboe. The evaluation was performed in the listening room of the Department of Computer Science, where different orchestral compositions could be reproduced as if performed in different concert halls (see, e.g., [14]). This gave the musicians the possibility to play and evaluate the hearing protectors with a virtual orchestra.

The goal of the evaluation at this stage was not to accurately prove the effectiveness of the proposed solution, but rather to make sure that the basic concept works, and to identify the future directions for developing the solution further. The musicians were thus allowed to freely play without and with the hearing protectors, with the different features (occlusion reduction, hear-through, monitoring) enabled or disabled, and with or without the orchestra recordings. The evaluation results were documented based on a free discussion between the authors and the musicians.

4.2.1 The need for and use of hearing protectors

Some of the musicians reported music-induced hearing loss and tinnitus, while others did not have any hearing disorders. All musicians recognized the need for hearing protection in their work, some occasionally while others more often. A few musicians mentioned that their need for hearing protection had decreased due to, e.g., seating arrangements in the orchestra.

When using hearing protection, the musicians typically used foam earplugs, and some often only in one ear. The trumpet player said that he felt a strong need for using hearing protectors, but that he never uses them when playing in an orchestra, since the booming sound caused by the earplugs overpowers the sound of both the rest of the orchestra and his own instrument. The other musicians mentioned different reasons for why they do not use hearing protectors more often: the sound of the instrument is bad; trebles get cut off; buzzing and other unwanted sounds get amplified and annoying; it takes a lot of time and effort to get used to playing with earplugs; you feel isolated from the rest of the orchestra; it is difficult to play in balance with the rest of the orchestra.

4.2.2 Occlusion reduction

The occlusion reduction had a different effect depending on the instrument. The trumpet player said that the booming sound caused by the earplugs vanished, and that he now was able to hear himself playing. The saxophonist reported a small but clear improvement of the instrument sound. The bassoonist said that the sound in some cases – depending on the note played – was more natural, but that it otherwise just made the sound different and more distant. The viola player felt that the timbre of the instrument became too bright. The clarinetist reported a clear change in the timbre, but it did not improve the sound; the unwanted sounds that were amplified by the earplugs remained. The flutist said that the sound became brighter and more spacious, which was an improvement over the stuffy sound caused by the earplugs.

The occlusion reduction comes with a noticeable degree of noise. During the evaluation, however, this noise was

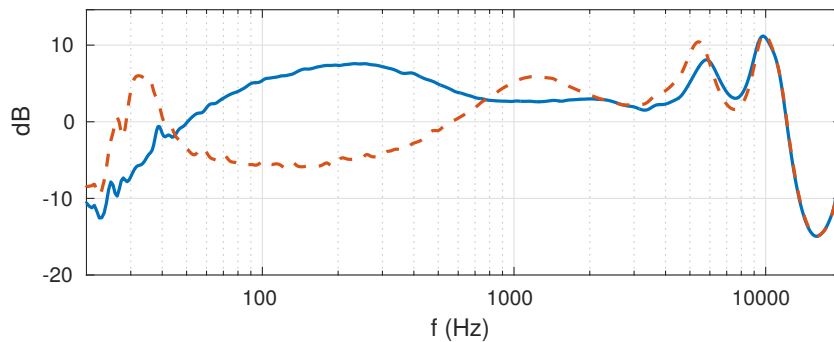

Figure 5: Magnitude response of the headphones, measured in the ear canal simulator with the eardrum microphone. The solid blue line represents the unprocessed response, while the dashed red line represents the response with the occlusion reduction circuit active.

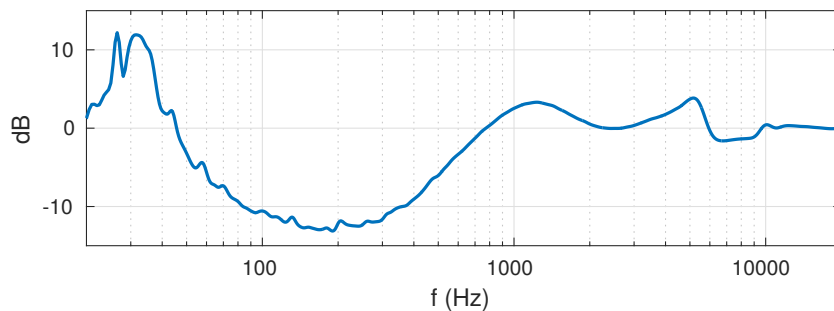

Figure 6: The effect of the occlusion reduction circuit on the magnitude response of the headphones, i.e., the difference between the solid blue line and the dashed red line in Fig. 5.

considered not to be loud enough to be disturbing, and the spectrum of the noise was also considered not to be disturbing.

4.2.3 Monitoring

The placement of the instrument microphones was chosen based on experimentation to provide a balanced and natural sound of the instrument. Although the prototype hearing protection solution supports connecting up to four instrument microphones, only two microphones were found to be necessary during the evaluation. These two microphones were in the end placed closed to each other, since this provided a balanced sound of all the instruments tested. On the viola, the microphones were placed at the bridge. On the bassoon, trumpet, saxophone, oboe, and clarinet, the microphones were placed at the side of the bell. On the flute and piccolo, the microphones were placed approximately one-third of the instrument's length from the end of the instrument closest to the mouthpiece.

Amplifying the sound of the instrument microphones, processed with HRTFs and with reverberation added, clearly improved the sound of the instrument. Most musicians commented that the sound was not completely natural, but quite pleasant. In many cases, slightly amplifying the equalized signal from the hear-through microphones further improved the sound.

Some of the musicians thought that the reverberation added to the sound was pleasant, while others felt that it was unnatural, or that there was either too little or too

much reverberation. Clearly, the level and quality of reverberation must be easily adjustable depending on the surrounding space, the instrument, and the preferences of the musician.

4.2.4 Playing alone

Especially the trumpet player, the saxophonist, and the piccolo player thought that the electronic hearing protectors would be good for practicing alone. When practicing in a small room, the sound of the instrument is often too loud due to strong reflections. With the electronic hearing protectors, however, the sound of the instrument can be attenuated, while still remaining quite clear and pleasant, unlike when using normal earplugs. The piccolo player summarized the experience: "It sounds good and natural, but it doesn't hurt, like it usually does."

4.2.5 Playing with an orchestra

The musicians tried the electronic hearing protectors while listening to a symphony orchestra recording and playing their instruments. The musicians commented that they were able to hear both their own instrument and the rest of the orchestra well. The flutist also commented that the sound of her own instrument was richer and more inspirational when playing with the electronic hearing protectors compared with regular earplugs. The saxophonist said that he could hear his instrument well and play with the orchestra, but wondered how he would be able to adjust his dynamics with respect to the rest of the orchestra, since

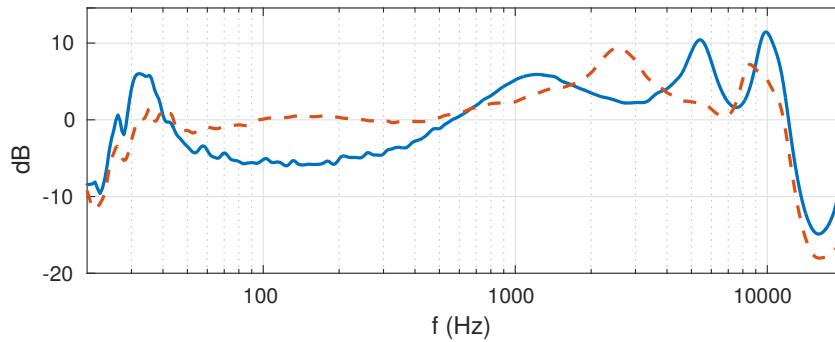

Figure 7: Equalization of the headphone response when reproducing the signals from the hear-through and instrument microphones. The solid blue line represents the unequalized magnitude response with the occlusion reduction circuit active. The dashed red line represents the equalized response. The measurements were performed in the ear canal simulator with the eardrum microphone.

the electronic hearing protectors alter the level of the own instrument and the orchestra independently.

4.2.6 Technical implementation

The rubber tips of the headphones did not fit well in the ears of all the musicians, and thus different sized tips would naturally be needed for different ear canal sizes. The need for custom ear molds also came up.

Based on the musicians' comments, the sound of the hearing protectors (timbre, balance between the musician's own instrument and the orchestra, and reverberation) should be easily adjustable, but preferably minimal adjustments should be needed to get the sound right. A few musicians also pointed out that it might be beneficial to adjust the hear-through level separately for each ear, since sometimes there are loud instruments that should be attenuated only on one side. Naturally, this would affect localization cues and the spatial perception of the auditory scene, and experiments should be performed to determine if such an effect is acceptable.

Based on the evaluation, the instrument microphones could be mounted on so called goosenecks, allowing easy adjustment of the microphone position. A single microphone might be enough in many cases, and seemed to provide a pleasant sound with the instruments in this evaluation (we actually used two microphones in all cases, but they were positioned very close to each other).

4.3 Discussion

The subjective evaluation of the prototype hearing protection system showed that the occlusion reduction in many cases improves the experience for the musician, by attenuating amplified bass frequencies and thus providing a timbre that is more pleasant and natural. With the ears plugged, the sound of the instrument can often appear as if it originates from inside the head, but in some cases the occlusion reduction can alleviate this problem.

The source of the noise that is heard when the occlusion reduction circuit is enabled is currently unclear. Unless the source is the self noise of the microphones, it could probably be reduced with more advanced circuit design. Another problem with the current occlusion reduction cir-

cuit design is the low-frequency boost that can be seen in Fig. 6. Although few musical instruments have energy at such low frequencies, this boost can, e.g., emphasize sound caused by the movement of the hearing protector cables, and should thus be addressed in future designs, if possible.

Adding the instrument microphone signals with HRTFs and reverberation makes the timbre brighter and more natural, and also makes the sound of the instrument seem as it originates from the instrument and not from inside the head. For most wind instruments, a bone-conducted buzzing sound from the reed or lips is normally prominent when playing with the ears occluded, making playing with ear plugs uncomfortable for many musicians. Adding the instrument microphone signals alleviates this problem, by altering the balance between air-conducted and bone-conducted sound to be more favourable and closer to natural.

Amplifying the instrument microphone signals will, however, affect the balance between the musician's own instrument and the other musicians' instruments when playing in an ensemble. The musician's instrument will thus sound louder than normal when compared with the sounds of other instruments. This balance will be, among other things, instrument specific, since all instruments have a different natural balance between air-conducted and bone-conducted sound. The balance between the musician's own instrument and the other instruments can of course be improved by amplifying the signals from the hear-through microphones. However, heavy amplification of these signals will counteract the function of the hearing protectors.

Adding reverberation to the instrument signals may be useful not only to aid in externalization and integrating the sound of the instrument into the surrounding acoustic environment. It can also be used for personal practice, making the instrument sound like it's being played in, e.g., a much larger hall. The possibilities to adjust the reverberation algorithm available on the DSP are, however, limited, and the available memory as well as the graphical development tool for programming the DSP limit the possibilities to develop other algorithms. Thus, a more versatile DSP would be needed in the future. Even with more sophisticated reverberation algorithms, the task of combining real and artificial reverberation is far from trivial. To minimize

the amount of manual adjustment needed, impulse sounds could be isolated from the hear-through microphone signals, and the characteristics of the real reverberation extracted from these.

The delay introduced by the DSP in the hear-through and instrument microphone signals can cause two different problems. A short delay will result in a comb-filtering effect, as the microphone signals reproduced through the headphones get summed with the sound leaking past the earplugs into the ear canals. The delay itself will become noticeable as it grows larger, affecting the performance of the musician. The allowable delay depends greatly on, e.g., the instrument type, but delays greater than 1 ms may already produce audible comb-filtering effects and delays greater than 6.5 ms can be perceived as audible delays with some instruments [15]. The situation gets more complicated as the sound of the other musicians' instruments also are delayed, and especially if several musicians are using similar hearing protectors. The delays of the prototype hearing protection solution were not measured. However, none of the musicians reported that the delay negatively affected their performance.

5. CONCLUSIONS

In this paper, we presented an electronic hearing protection solution designed especially for musicians. The solution combines the following features: reduction of the occlusion effect, monitoring of the musician's own instrument, adjustable attenuation, and natural timbre. Seven professional musicians evaluated the implemented solution and confirmed that these features together alleviate problems associated with musicians' hearing protection. Thus, the findings presented in this paper will hopefully lead to better hearing protectors in the future and more musicians that are able to satisfactorily protect their hearing.

Acknowledgments

The work leading to these results was partially funded by the Finnish Work Environment Fund, project no. 115145. The authors would like to thank the musicians that participated in the evaluation of the proposed hearing protection solution. The authors would also like to thank professor emeritus Jukka Ylikoski for consultation at the beginning of the project.

6. REFERENCES

- [1] S. Stenfelt and S. Reinfeldt, "A model of the occlusion effect with bone-conducted stimulation," *International Journal of Audiology*, vol. 46, no. 10, pp. 595–608, 2007.
- [2] H. Laitinen, "Factors affecting the use of hearing protectors among classical music players," *Noise & Health*, vol. 7, no. 26, pp. 21–29, 2005.
- [3] K. R. Kähäri, "The influence of music on hearing. a study in classical and rock/jazz musicians," Ph.D. dissertation, University of Gothenburg, Sweden, 2002.
- [4] R. Albrecht, T. Lokki, and L. Savioja, "A mobile augmented reality audio system with binaural microphones," in *Proceedings of the Interacting with Sound Workshop*, Stockholm, Sweden, 2011, pp. 7–11.
- [5] J. Mejia, H. Dillon, and M. Fisher, "Active cancellation of occlusion: An electronic vent for hearing aids and hearing protectors," *The Journal of the Acoustical Society of America*, vol. 124, no. 1, pp. 235–240, 2008.
- [6] R. Borges, M. Costa, J. Cordioli, and L. Assuiti, "An adaptive occlusion canceller for hearing aids," in *Proceedings of the 21st European Signal Processing Conference*, Marrakech, Morocco, 2013.
- [7] M. Sunohara, K. Watanuki, and M. Tateno, "Occlusion reduction system for hearing aids using active noise control technique," *Acoustical Science and Technology*, vol. 35, no. 6, pp. 318–320, 2014.
- [8] A. Bernier and J. Voix, "Active musician's hearing protection device for enhanced perceptual comfort," in *EuroNoise 2015*, Maastricht, the Netherlands, 2015, pp. 1773–1778.
- [9] R. W. Lindeman, H. Noma, and P. G. de Barros, "Hear-through and mic-through augmented reality: Using bone conduction to display spatialized audio," in *Proceedings of the 6th International Symposium on Mixed and Augmented Reality*, Nara, Japan, 2007, pp. 173–176.
- [10] P. F. Hoffmann, F. Christensen, and D. Hammershøi, "Insert earphone calibration for hear-through options," in *51st International Audio Engineering Society Conference*, Helsinki, Finland, 2013.
- [11] J. Catic, S. Santurette, and T. Dau, "The role of reverberation-related binaural cues in the externalization of speech," *The Journal of the Acoustical Society of America*, vol. 138, no. 2, pp. 1154–1167, 2015.
- [12] T. Qu, Z. Xiao, M. Gong, Y. Huang, X. Li, and X. Wu, "Distance-dependent head-related transfer functions measured with high spatial resolution using a spark gap," *IEEE Transactions on Audio, Speech, and Language Processing*, vol. 17, no. 6, pp. 1124–1132, 2009.
- [13] W. R. Thurlow and C. E. Jack, "Certain determinants of the 'ventriloquism effect'," *Perceptual and Motor Skills*, vol. 36, no. 3 suppl., pp. 1171–1184, 1973.
- [14] T. Lokki, J. Pätynen, A. Kuusinen, and S. Tervo, "Concert hall acoustics: Repertoire, listening position, and individual taste of the listeners influence the qualitative attributes and preferences," *The Journal of the Acoustical Society of America*, vol. 140, no. 1, pp. 551–562, 2016.
- [15] M. Lester and J. Boley, "The effects of latency on live sound monitoring," in *Audio Engineering Society Convention 123*, New York, NY, USA, 2007, paper no. 7198.